



Stretcher X2



reddot winner 2022
medical devices and technology



The **Stretcher X2** is designed to meet the fast-paced demands of today's hospitals, emergency departments, and outpatient clinics. With **18 kg less weight** than the previous X generation, it offers superior maneuverability without compromising stability or safety.

Patient comfort and safety first

With the patient as the crucial consideration, Stretcher X2 is designed to ensure enhanced patients' protection and comfort. The electric models offer **low access height** of 49 cm (+ mattress) — ideal for elderly or less mobile patients. Hydraulic models go as low as 52 cm. **Patented safety rails** extend nearly the full length of the trolley. They ensure optimal patient safety. **Multiple mattress options** allow tailored support throughout patient stay.

Versatility and support for medical staff

All models enable **effortless positioning** for caregivers. In hydraulic models, height and Anti/Trendelenburg positioning are adjusted using **foot pedals**, allowing hands-free operation and full attention on the patient. In electric models, both height and sections of the tabletop are adjusted via an **intuitive hand switch**. Adjustments are quick and easy, whether powered by battery or supported by gas springs.

Effortless maneuverability and smooth transport

All Stretcher X2 models are lightweight and exceptionally agile, supporting a **320 kg safe working load**. Large castors and **central locking system** ensure smooth and controlled movement. The optional **fifth wheel** makes on-the-spot turning effortless—even for a single caregiver. **Corner bumpers** protect the trolley and surroundings. Ergonomic **push handles** and two **integrated storage spaces** support caregiver workflow in any clinical setting.

With **award-winning design and functionality**, the Stretcher X2 is more than just a trolley—it's a trusted partner in delivering high-quality patient care.

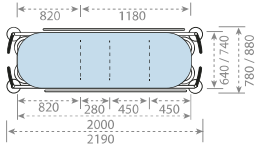

STRETCHER X2 - hydraulic



CONFIGURE

Whether for emergency care, patient transport, or examinations, the **Stretcher X2 - hydraulic** is the right solution for busy clinical settings.

Height and the Anti/Trendelenburg position are adjusted via foot pedals, while gas springs assist with the manual adjustment of individual sections of the lying surface. The low access height, patented safety rails, and large castors ensure safe and easy handling.

Awarded for its design and functionality, it's the equipment your team can count on.

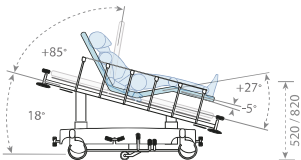
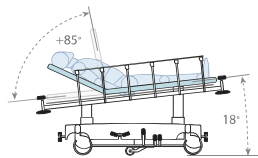

POSITIONS

Infusion stand (SIF-X2)

- height adjustable
- easy click system on all four corners

Vertical oxygen bottle holder (O2-V120/140)

- attached to fixation rails
- two versions to fit Ø 120 mm or Ø 140 mm bottles

Built-in storage space (POM-X2)

- 6,5 l space for tablet or monitoring device under head section

Fifth wheel (PK-X2)

- allows easy maneuvering and turning on the spot
- castor Ø100 mm

Hydraulic height adjustment

- between 52 and 82 cm
- easy patient access
- adjusted by foot pedals on both sides

Transfer mattress (MAT-6/8/10H-X2)

- handles on both sides for transferring the patient together with the mattress
- three types with different structure and thickness (6, 8 or 10 cm)

MODEL: STRX2-H2



Fixation rails (LE-X2/S/Z)

- at head, foot and along lying section
- made of stainless steel

Castor central locking system

- features dual end controls (SER-2CK-X2) and antistatic directional castor (SER-SK-X2)
- optional: four-sided controls (4CK-X2)

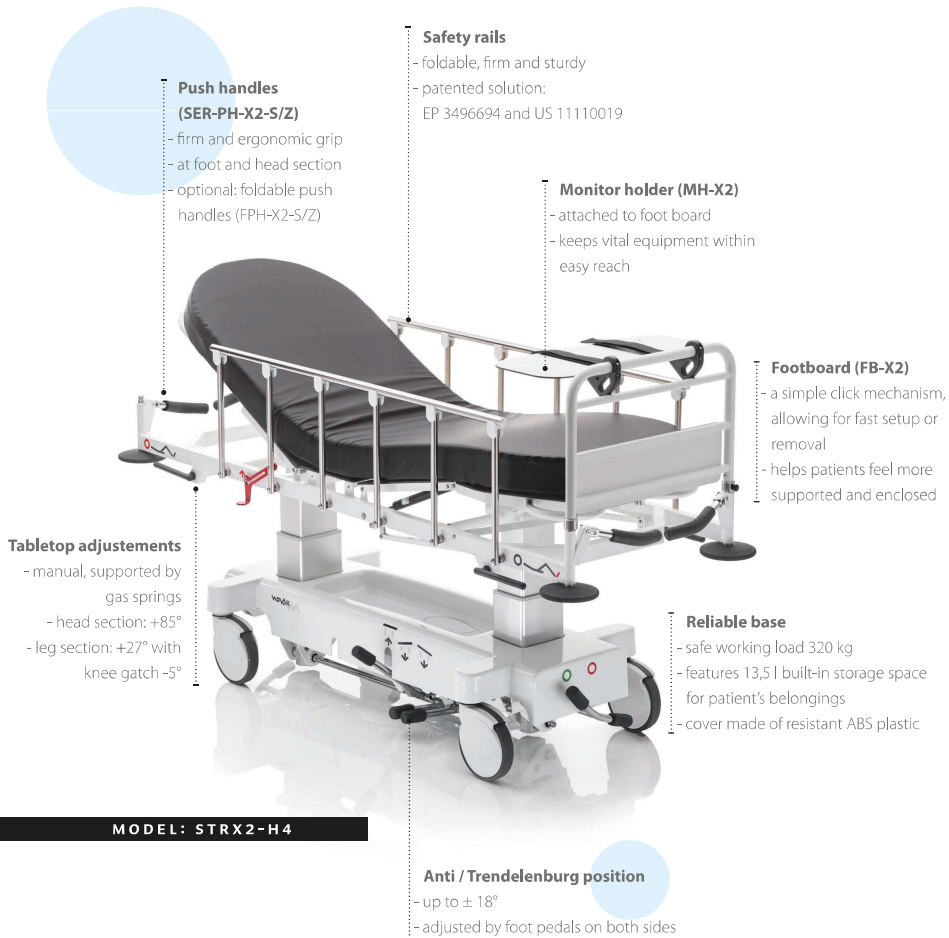

MODEL: STRX2-H4

Equipment and accessories

standard ● optional ○

Equipment and accessories	STRX2-H2	STRX2-H4
safety rails	●	●
central locking system with dual end controls – SER-ZCK-X2	●	●
central locking system with four-sided controls – 4CI-X2	○	○
push handles at head and foot section – SER-PH-X2-S, SER-PH-X2-Z	●	●
foldable push handles – FPH-X2-S, FPH-X2-Z	○	○
directional antistatic castor, Ø 200 mm – SER-SK-X2	●	●
fifth wheel, Ø 100 mm (1 pc) and additional antistatic castor, Ø 200 mm (1 pc) – PK-X2	○	○
fixation rails at lying, head or leg section – LF-X2, LE-X2-S, LE-X2-Z	○	○
paper roll holder – NZP-X2	○	○
infusion stand with holder (1 pc) – SIF-X2	○	○
foldable infusion stand (1 pc) – SIF-XF	○	○
oxygen bottle holder – O2-X2 (45 cm), O2-X2-L (55 cm)	○	○
vertical oxygen bottle holder – O2-V120 (Ø12 cm), O2-V140 (Ø14 cm)	○	○
monitor holder – MH-X2	○	○
footboard – FB-X2	○	○
antistatic castor (1 pc) – AC-X2	○	○
integrated storage space on the base cover (13,5 l)	●	●
integrated storage space under head section (6,5 l) – POM-X2	○	○
safety rail pads (pair) – SRP-X2	○	○
transfer mattress responsive (6 cm) – MAT-6H-X2	○	○
transfer mattress comfort (8 cm) – MAT-8H-X2	○	○
transfer mattress extra comfort (10 cm) – MAT-10H-X2	○	○
non-slip mattress responsive (6 cm) – MAT-6-X2	○	○
non-slip mattress comfort (8 cm) – MAT-8-X2	○	○
non-slip mattress extra comfort (10 cm) – MAT-10-X2	○	○
ESD drag chain – STE-X2	○	○
plug connector for potential equalization – PPEQ	○	○

Regulatory compliance

The product complies with the **Medical Device Regulation (EU) 2017/745** and the following standards:

- **EN 60601-1:2005 + A1:2012 + A2:2020** – Basic safety and essential performance
- **EN 60601-1-6:2010 + A1:2013 + A2:2020** – Usability requirements
- **EN ISO 9001:2015** – Quality management systems
- **EN ISO 13485:2016** – Quality management for medical devices
- **EN ISO 14971:2019** – Risk management

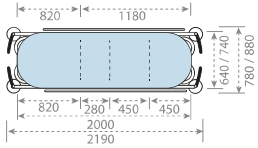

STRETCHER X2 - electric



CONFIGURE

Designed for demanding hospital workflows, the **Stretcher X2 - electric** enhances patient comfort and streamlines caregivers' tasks.

The low entry height ensures safe and easy access. The electric height and position adjustments minimize physical strain. Pre-set positions and synchronized section movement save valuable time in everyday care.

It's the ideal choice for departments where speed, efficiency, and patient safety come first.

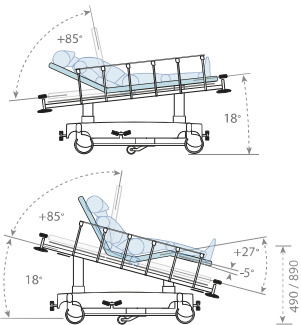

POSITIONS

Electric height adjustment

- operated via hand switch
- range between 49 and 89 cm
- battery powered



Non-slip mattress (MAT-6/8/10-X2)

- with Velcro strips to prevent sliding
- responsive (6 cm), comfort (8 cm) and extra comfort (10 cm)

Safety rail pads (SRP-X2)

- provide extra protection and comfort
- durable PU material
- attachment via Velcro strips



Oxygen bottle holder (O2-X2/L)

- conveniently attached under the head section
- two versions to fit 45 cm and 55 cm bottles

SOS head section release

- lever for manual adjustment of head section
- to act quicker in emergencies

Easy maneuvering and handling

- four castors Ø 200 mm with central locking system
- suitable for up to 5° slopes (elevation of 78 mm over 1 m)

Paper roll holder (NZP-X2)

- positioned under foot end
- quick and easy preparation of a clean surface for the next patient

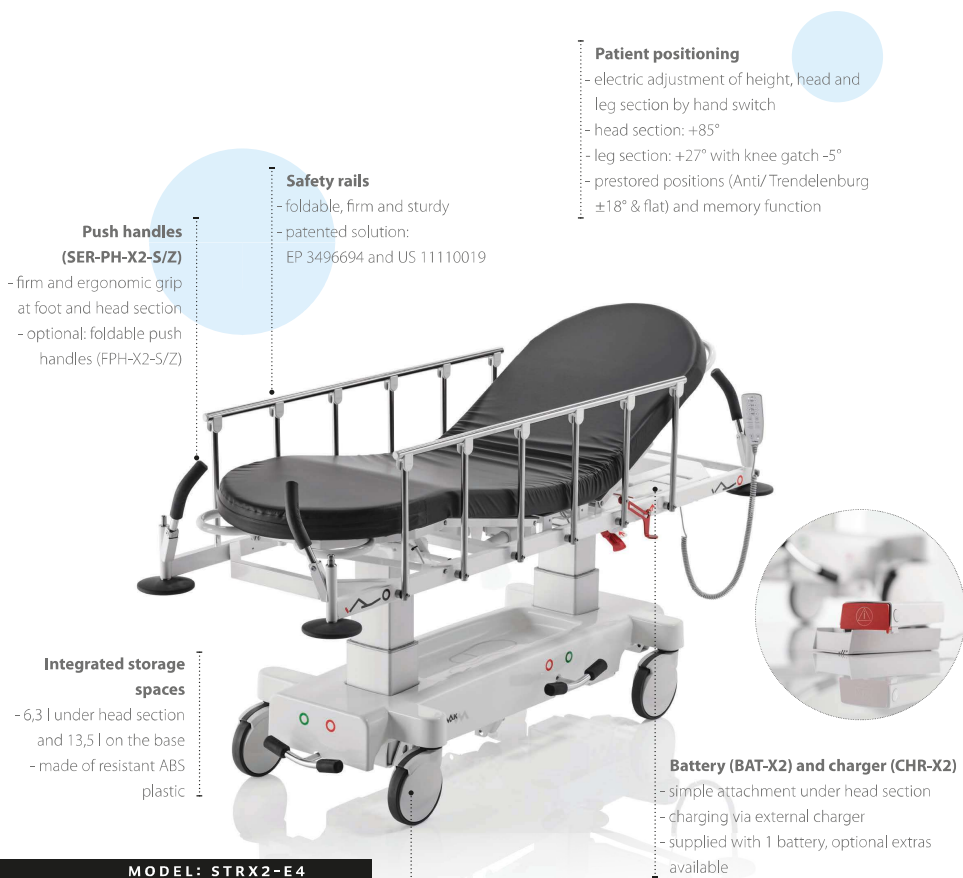

Patient positioning

- electric adjustment of height, head and leg section by hand switch
- head section: +85°
- leg section: +27° with knee gatch -5°
- prestored positions (Anti/ Trendelenburg ±18° & flat) and memory function

Safety rails

- foldable, firm and sturdy
- patented solution: EP 3496694 and US 11110019

Push handles (SER-PH-X2-S/Z)

- firm and ergonomic grip at foot and head section
- optional: foldable push handles (FPH-X2-S/Z)

Integrated storage spaces

- 6,3 l under head section and 13,5 l on the base
- made of resistant ABS plastic

Battery (BAT-X2) and charger (CHR-X2)

- simple attachment under head section
- charging via external charger
- supplied with 1 battery, optional extras available

Castor central locking system

- dual end controls (SER-2CK-X2) and antistatic directional castor (SER-5K-X2)
- optional: four-sided controls (4CK-X2) and 5th wheel (PK-X2)

MODEL: STRX2-E4

Equipment and accessories

standard ● optional ○

Equipment and accessories	STRX2-E2	STRX2-E4
integrated storage spaces on the base cover (13,5 l) and below the head section (6,3 l)	●	●
safety rails	●	●
central locking system with dual end controls – SER-2CK-X2	●	●
central locking system with four-sided controls – 4CK-X2	○	○
push handles at head and foot section – SER-PH-X2-S, SER-PH-X2-Z	●	●
foldable push handles – FPH-X2-S, FPH-X2-Z	○	○
directional antistatic castor, Ø 200 mm – SER-5K-X2	●	●
fifth wheel, Ø 100 mm (1 pc) and additional antistatic castor, Ø 200 mm (1 pc) – PK-X2	○	○
fixation rails at lying, head or leg section – LE-X2, LE-X2-S, LE-X2-Z	○	○
paper roll holder – NZP-X2	○	○
infusion stand with holder (1 pc) – SIF-X2	○	○
foldable infusion stand (1 pc) – SIF-XF	○	○
oxygen bottle holder – O2-X2 (45 cm), O2-X2-L (55 cm)	○	○
vertical oxygen bottle holder – O2-V120 (Ø12 cm), O2-V140 (Ø14 cm)	○	○
monitor holder – MH-X2	○	○
footboard – FB-X2	○	○
antistatic castor (1 pc) – AC-X2	○	○
safety rail pads (pair) – SRP-X2	○	○
transfer mattress responsive (6 cm) – MAT-6H-X2	○	○
transfer mattress comfort (8 cm) – MAT-8H-X2	○	○
transfer mattress extra comfort (10 cm) – MAT-10H-X2	○	○
non-slip mattress responsive (6 cm) – MAT-6-X2	○	○
non-slip mattress comfort (8 cm) – MAT-8-X2	○	○
non-slip mattress extra comfort (10 cm) – MAT-10-X2	○	○
additional battery – BAT-X2	○	○
battery charger – CHR-X2	○	○
ESD drag chain – STE-X2	○	○
plug connector for potential equalization – PPEQ	○	○

Regulatory compliance

The product complies with the **Medical Device Regulation (EU) 2017/745** and the following standards:

- **EN 60601-1:2005 + A1:2012 + A2:2020** – Basic safety and essential performance
- **EN 60601-1-2:2014 + A1:2020** – Electromagnetic disturbances: Requirements and tests
- **EN 60601-1-6:2010 + A1:2013 + A2:2020** – Usability requirements
- **EN ISO 9001:2015** – Quality management systems
- **EN ISO 13485:2016** – Quality management for medical devices
- **EN ISO 14971:2019** – Risk management



Bring treatment to a higher level!

.....

Novak M d.o.o.

Pod kostanji 7
SI - 1218 Komenda

E: info@novak-m.si
T: +386 1 5620117

www.novak-m.com